



13.540

Gravity Corer – Ø101,6 mm

Manual

KC Denmark A/S

Research Equipment
Limnology • Oceanography • Hydrobiology

Gravity Corer – Ø101,6 mm



Caution

The gravity corer is very dangerous in unskilled hands, and you must take serious precautions to avoid accidents.

KC Denmark A/S is not, and cannot be held, responsible for any damage(s) made to equipment or to operators who ignore safety precautions or because of misuse or wrong operation.

Never walk under the gravity corer, when lifted by the winch.

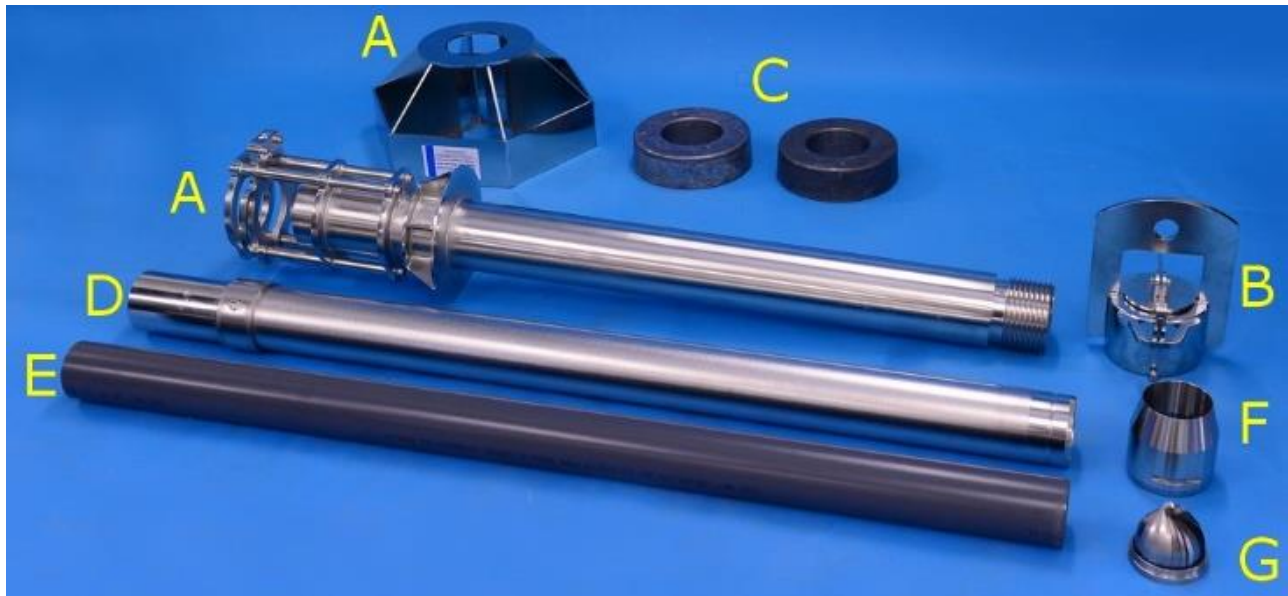

Standard delivery comes with these items:





- A. Main rack with support for 10 lead weights, each 20 kg
- B. Top part with non-return lid
- C. 2 lead weights, each 20 kg (13.546)
- D. Sample tube, stainless steel, length 1,5 m (13.541)
- E. Internal liner, length 1,5 m (13.545)
- F. Carver (13.544)
- G. Orange peel (13.547)

Sample depth:

Sample tubes are available in lengths of either 1,5 or 3 m. We recommend a max. length of 12 m.

Piston corer functionality (optional):

All our gravity corers support an extension kit, adding piston corer functionality thus having a versatile 2 in 1 product, where you can switch forth and back within few minutes. For this corer you may add order no. 13.560.

Item	Preparation	
1	<p>Add the necessary number of lead weights at the main rack. Now mount the supporting frame and secure it by fastening the bolt.</p>	
Gravity corer option:		
2	<p>For gravity corer operation, you must mount the unit with the top lid.</p> <p> Caution</p> <p>Fasten the unit and secure with the M8 x 16 bolt "A"</p> <p>Ensure the black rubber "B" is free of dirt.</p>	
3	<p>Open the fastening device and push the tube with the mechanical stop into the bottom. Lock the handles, C and D, and secure with a bolt.</p>	

4	<p>Close the handles correctly and secure the handles with the bolt, E.</p>	
5	<p>You may add more tubes, using the coupling device and 4 spikes; see next item.</p> <p>Available tubes for extension: 13.542 (1,5 m) and 13.558 (3,0 m).</p>	
6	<p>Insert the PVC liner into the steel tube; add the orange peel "G" and you can now attach the carver "F".</p> <p>Fasten with 2 spikes.</p>	
7	<p>The gravity corer is now ready, to be lowered into the sea. You must control the speed and lower at a reasonable speed, otherwise the corer may tilt over, and you will get no sample.</p>	

Piston corer option:

Requires the extension 13.560 (optional), see photo to the right.

The principle for operating the piston corer function:

An AISI 316 stainless steel heavy-duty releaser (pos. 1), based on the Kullenberg principle, is mounted at the top. The corer supports a maximum of 10 lead weights (pos. 4) each 20 kg. The upper part of the corer is made of AISI 316 stainless steel.

The corer tube (pos. 9) is made of AISI 316 stainless steel $\varnothing 101,6$ mm supporting an internal liner with diameter $\varnothing 90$ mm. At the end of the releaser hook (pos. 1); the 30 kg release weight (pos. 7) is mounted.

A piston with a leather seal, (pos. 8) is positioned at the bottom of the corer tube. The piston is connected to the releaser (pos. 1) by an $\varnothing 8$ mm stainless steel wire. During the deployment the corer tube (pos. 9) is released 1,7 m above the sediment as the releaser weight reaches the sediment surface.

The wire (pos. 8), which has a slack of about 1 m, allows the corer tube to fall free until the piston (pos. 7) is activated just before the corer tube enters the sediment. The total weight load can regulate the depth of penetration. (pos. 4).

Standard delivery comes with a 1,5 m sample tube; using another length of tube requires a wire set (pos. 6 and 8) with a corresponding length.

- 1 - Kullenberg releaser
- 2 - Wire ($\varnothing 8$ mm) for piston
- 3 - Steering fins
- 4 - Lead weight
- 5 - Lock for corer tube
- 6 - Wire ($\varnothing 5$ mm) for Kullenberg releaser and 30 kg weight station
- 7 - 30 kg weight station
- 8 - Piston
- 9 - Corer tube
- 14 - Safety split

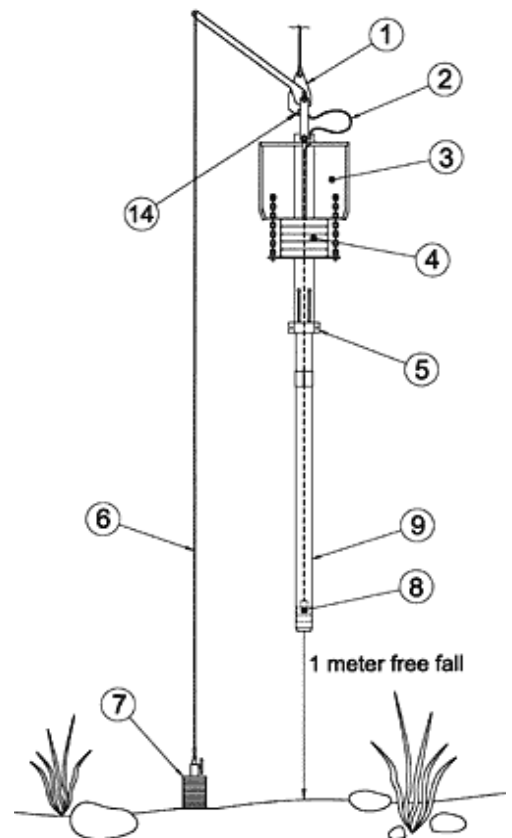
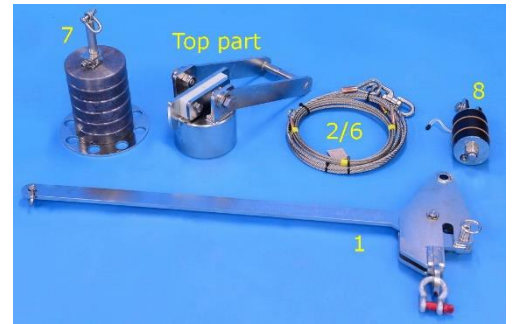

Remove the upper part (shown as item 2) from the main rack and mount the upper part for piston corer.

9







Fasten the unit and secure with the M8 x 16 bolt, similar to "A" shown in item 2.







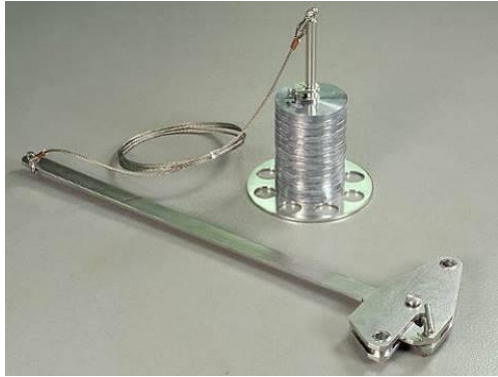

10

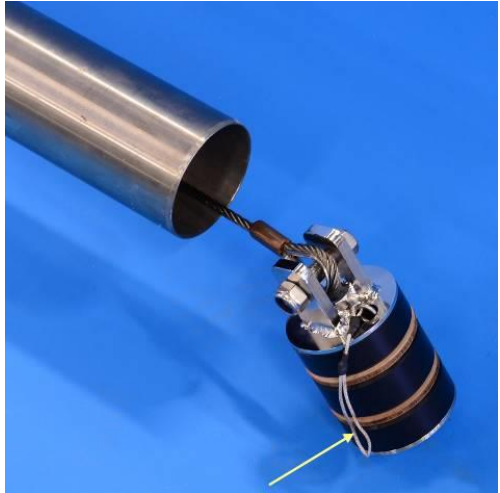
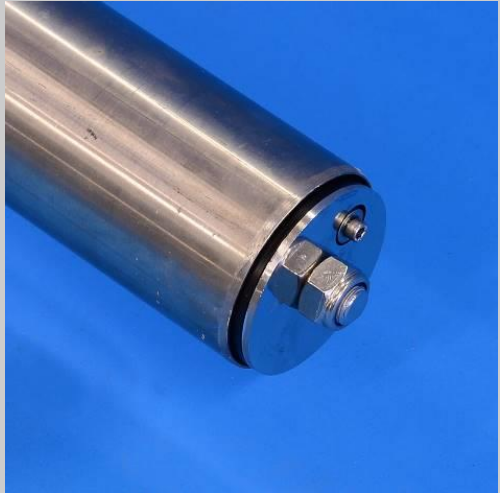

Attach the Kullenberg releaser arm with the bracket and mount two bolts, F and G



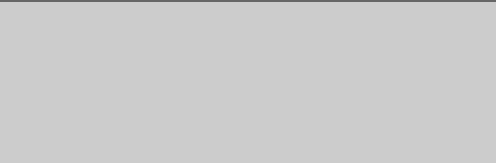



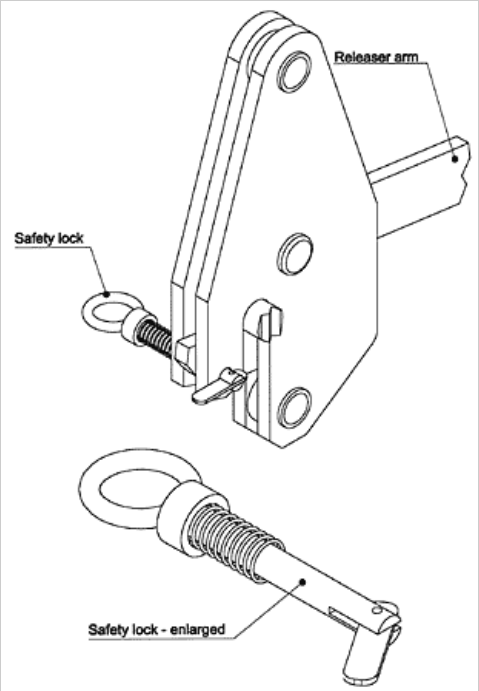

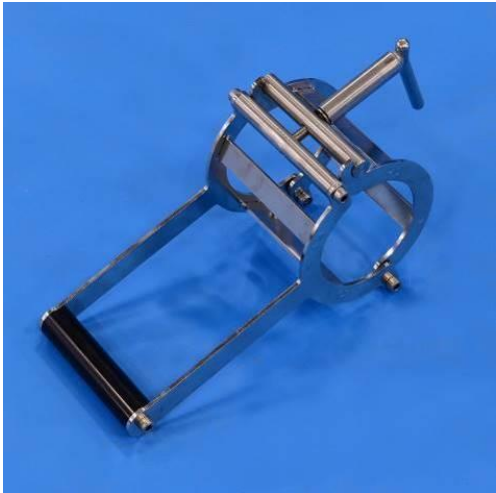

<p>11</p>	 <p>Caution</p> <p>Mount the security lock for the Kullenberg to avoid any unattended release. Lift the release arm until the lock fits for the square hole, insert and lock.</p>	
<p>12</p>	<p>The wire from the weight station is attached to the end of the arm of the Kullenberg releaser</p>	
<p>13</p>	<p>A wire-tightener (i.e., 2 pcs PE-HD plastic plate's arrangement) is placed at the top of the main rack.</p>	

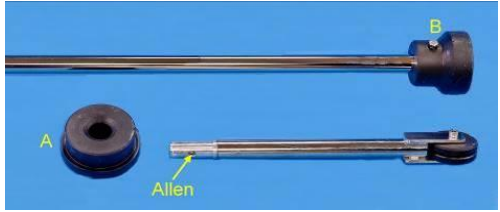
14	<p>Dismount the piston from the wire, see item 6, pos. 2. Guide the wire to the main rack and the core tube and mount the piston again. To ensure the piston will be in right position during the sample taking, adjust the wire-tightener, so the wire can be moved easily by hand, but the piston will remain in the core tube.</p> <p>Guide the wire (with the swivel in front) through the main rack and the corer tube. The swivel must remain at top of the main rack).</p>	
15	<p>Before inserting the piston at the bottom of the tube, make sure the white cord does not get stuck by the piston.</p>	
16	<p>Push the piston into the tube having a free space of 3-4 cm from the end of the tube; on the photo, the piston remains 5-6 cm to have a correct insertion.</p>	
17	<p>Mount the wire with the swivel part at the piston outside the end of the corer tube. Then press the piston into the corer tube on level with the corer edge.</p>	

<p>18</p>	<p>The piston for piston corer function.</p> <p>When the sample has been taken, there is a huge vacuum at top of the piston and pulling the white cord will align the pressure. Otherwise, it's very difficult to remove the corer tube.</p>	
<p>19</p>	<p>Tighten the PE-HD arrangement a little bit to ensure against a piston fall-out at sudden movements. Use bolts J and K.</p>	
<p>20</p>	<p>Mount the wire end with its steel thimble to the KULLENBERG releaser (pos. 1) by the steel bolt. (Do not forget to make a control check).</p>	
<p>21</p>	<p>You may attach the liners into the steel tube adding the orange peel system and the carver. Fasten with two spikes.</p> <p><i>For different lengths of corer tubes the steel wires much be replaced with the appropriate length.</i></p>	

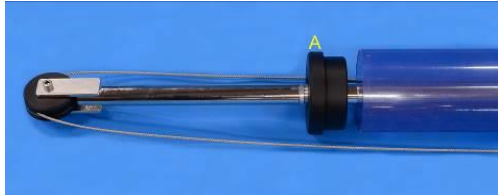
22	<p>The piston corer is now ready for operating.</p> <p>When the piston corer is hinged outboard the ship, remove the safety-lock (pos. 14) and the piston corer is ready for use.</p>	
23	 <p>Caution</p> <p>WARNING: Never remove the safety lock before the piston corer is outboard the ship. It poses great danger for personnel to remove the safety lock inboard the ship.</p>	
Emptying the corer tube		
24	<p>Requires the following items:</p> <ul style="list-style-type: none"> • 13.548 – Piston rod + 13.559 extension • 13.549 – Drum with ratchet device • 13.569 – Detacher for the tube • 13.904 – Trestles, see item 33, alternatively on the ship's deck <p>Photo shows the tube detacher for removal and handling of the core tubes.</p>	

25	<p>If you cannot remove the sample tube by hand, use the tube detacher. Tighten the handle, grab the black handle and turn counterclockwise to release the tube.</p>	
26	<p>Place the corer tube horizontally on 2 trestles (see item 33) or on deck.</p> <p>If you have added the extension kit for piston corer functionality, you must first remove the piston.</p> <p>If you cannot remove the piston due to heavy vacuum, pull the white cord to align the vacuum.</p>	
27	<p>Fasten the ratchet device by means of A and B; see item 32; it will only fit on the steel tube's reinforcement. For the PVC tube, it will fit anywhere.</p> <p>Do not over tighten "A" and "B", as it may cause damage to the PVC tube; furthermore, the piston may be stuck because of the deformation of the tube.</p>	
28	<p>Insert piston B at the end of the sample tube and then slide adapter A down the steel tube. The smallest part of the adapter must point towards the sample tube.</p>	
29	<p>Insert the tube with the wheel at opposite end of the steel tube; the tube has a small hole. Align this hole over the Allen screw; unscrew the Allen screw counterclockwise to lock the tubes.</p>	

30	The adapter A will fit into the sample tube to centre the piston rod during ejection.	
31	The adapter A is now in the correct position.	
32	<p>Push D and release C; now the lock for the wire has been disabled, pull out the wire E and guide it over the wheel, see item 29/30. Attach the snap hook at the end of the wire to the eye F.</p> <p>Push C into opposite position and by turning the handle forth and back, you will now force the piston through the sample tube ejecting the sample.</p>	
33	<p>Trestles made of AISI 316 stainless steel will secure the core tubes in a convenient working height.</p> <p>We can provide replaceable jaws of different sizes allow using a wide range of tube diameters.</p>	

Maintenance	
34	All parts of the piston corer can be rinsed using salt water or fresh water. For storing, we recommend a regular cleaning with fresh water only. Check that all parts are clean and free of sediment or sludge. For movable parts, you may smear with a thin oil, like WD-40 or a similar product.

Safety Regulations	
<p>KC Denmark A/S is not, and cannot be held, responsible for any damage(s) made to equipment or to operators who ignore safety precautions or because of misuse or wrong operation.</p> <p>An expert maintenance technician fully familiar with the attendant hazards must only do all maintenance, inspection and repairs.</p>	

When working with the unit in areas, which are difficult to access or hazardous, ensure to take adequate safety precautions for the operator and others in compliance with the provisions of law on health and safety at work.

Replace worn component with original spare parts.

Rev.: January 31, 2021 - lkj

KC Denmark A/S

Research Equipment
Limnology • Oceanography • Hydrobiology

E-mail: sales@kc-denmark.dk website: <http://www.kc-denmark.dk/>

Holmbladsvej 17-19, DK 8600 Silkeborg, Denmark. Tel. +45 86 82 83 47

Bank: Sydbank. SWIFT: SYBKDK22 - IBAN DK5070460000104832

VAT no. DK 29 61 96 62